

SAVER



FALL ARRESTER WITH RESCUE MECHANISM / SRL-R

The high-acclaimed SAVER is a retractable type fall arrester with an integrated emergency rescue mechanism (SRL-R 3-way).

May be used in conjunction with appropriate, certified anchorages and harnesses in confined space / fall protection applications.



SAVER fitted to a SENTRY Tripod



- Recovery winch with anti-run brake
- Shock absorbing brake mechanism
- Approx. 3 m per minute retrieval
- Stopping distance 0.6 m to 1 m
- Snaphook karabiner with fall indicator
- Synthetic rope option

Our TF heat-treated aluminium castings are ultra robust and durable, capable of withstanding the harshest conditions and rough treatment.

The rope is secured with a secondary backup feature to ensure full protection even at the rope termination.

SAVER ACCESSORIES



Arrester brackets enable a SAVER or STOP fall arrester (SRL) to be securely fitted to a SENTRY Tripod.

GSE230AB14 (for 10-14 m)
GSE230AB20 (for 20 m)
GSE230AB34 (for 25-30 m)



Holdall Bag
GSE-H/ALL



GSE430G

GSE414G

SETTING UP THE SAVER SRL-R

GLOBESTOCK
SAFETY

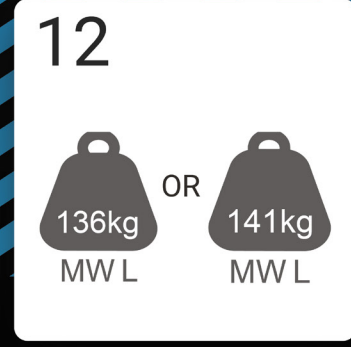
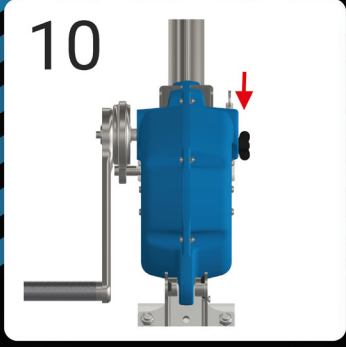
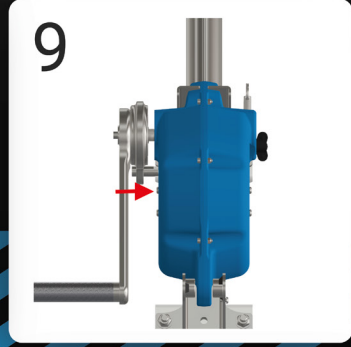
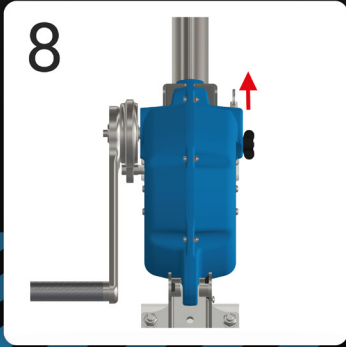
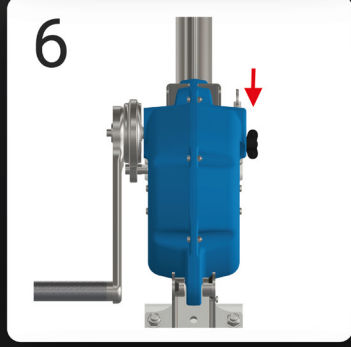
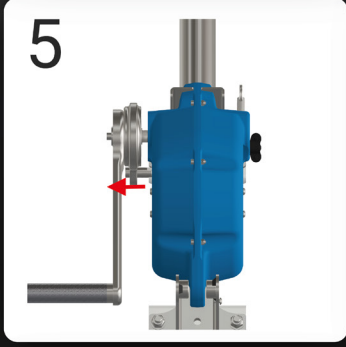
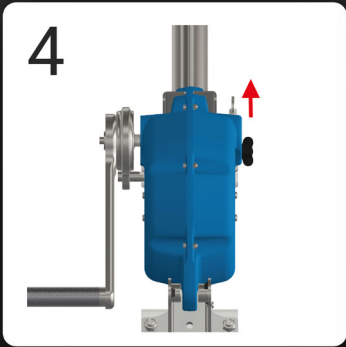
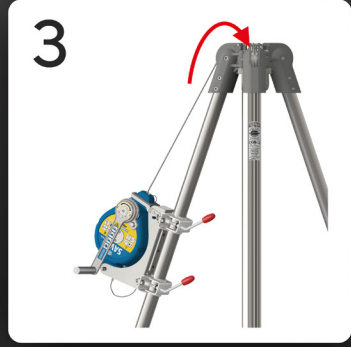
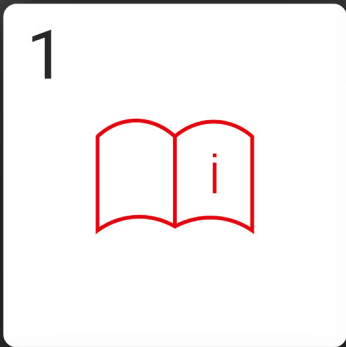

Product Code	Conformity	Max. Working Load	Min. Working Load	Lifeline Length	Lifeline / Snap Hook Material
GSE414G	EN 360: 2023 / EN 1496:2017 Class A / ANSI/ASSP Z359.14-2021 / CSA Z259.2.2-17 / AS-NZS 1891.3-2020	141 kg / 310 lb	60 kg / 132 lb	14 m / 46 ft	Zinc plated steel
GSE410SSK				10 m / 32 ft	Stainless steel
GSE414P				14 m / 46 ft	Synthetic life-line, zinc plated steel snap hook
GSE430G				30 m / 98 ft	Zinc plated steel
GSE425SSK				25 m / 82 ft	Stainless steel
GSE430P				30 m / 98 ft	Synthetic life-line, zinc plated steel snap hook

GSE414G / GSE410SSK / GSE414P
Measurements

